

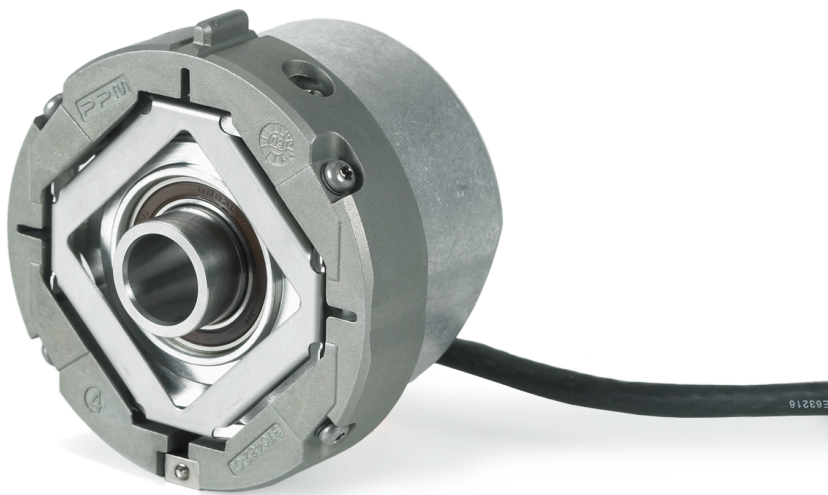

HEIDENHAIN



Product Information

ECN 425 **EQN 437**

Absolute Rotary Encoders
with Hollow Shaft and
Expanding Ring Coupling for
Safety-Related Applications

**Functional
Safety**

04/2019

ECN 425, EQN 437

Rotary encoders for absolute position values with safe singleturn information

- Installation diameter 65 mm
- Expanding ring coupling 07B
- Blind hollow shaft $\varnothing 12.7$ mm for axial clamping (67M)
- IP64 protection

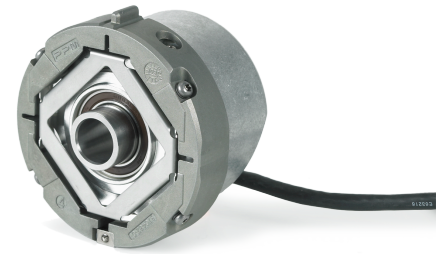

Functional Safety

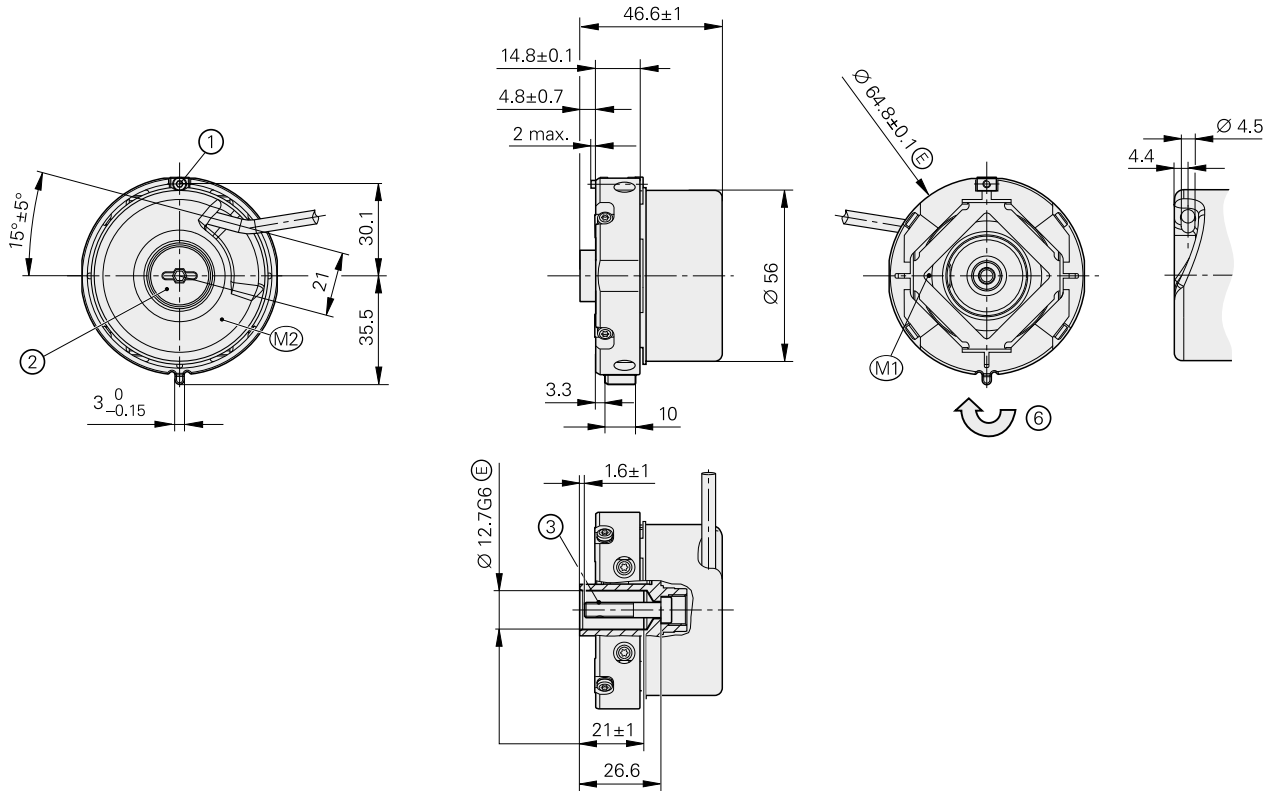

Required mating dimensions

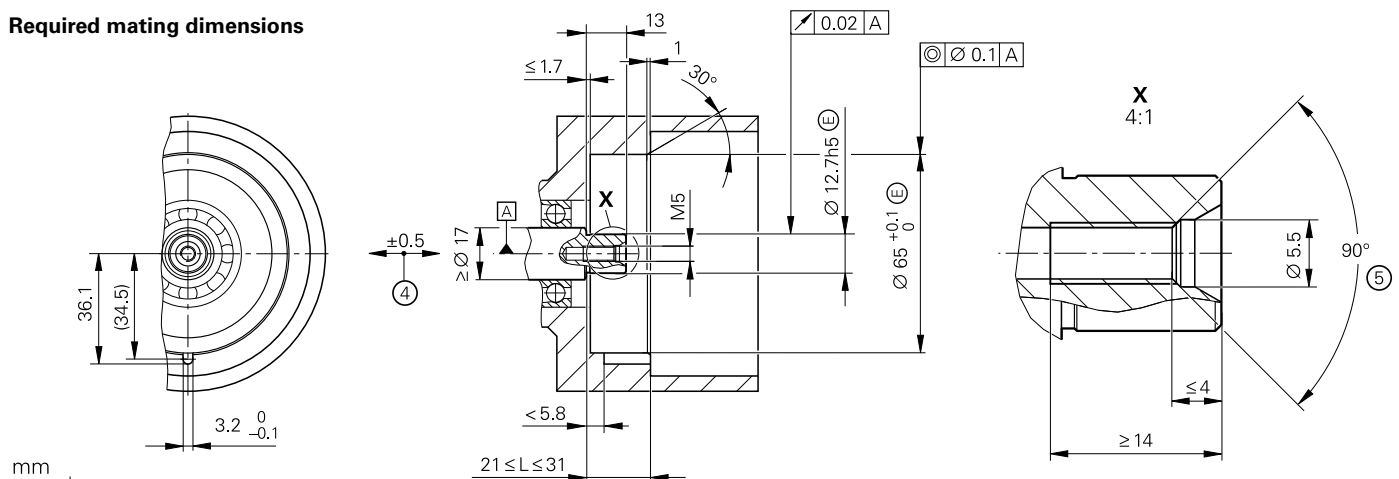

mm
 Tolerancing ISO 8015
 ISO 2768 - m H
 < 6 mm: ± 0.2 mm

- ⊠ = Bearing of mating shaft
- M1 = Measuring point for operating temperature
- M2 = Measuring point for vibration, see D 741714
- 1 = Clamping screw for coupling ring, width A/F 2, tightening torque 1.25–0.2 Nm
- 2 = Screw plug, widths A/F 3 and 4, tightening torque 5+0.5 Nm
- 3 = Screw DIN 6912 – M5x25 – 08.8 – MKL width A/F 4, tightening torque 5+0.5 Nm
- 4 = Compensation of mounting tolerances and thermal expansion, no dynamic motion permitted
- 5 = Chamfer at start of thread is obligatory for materially bonding anti-rotation lock
- 6 = Direction of shaft rotation for ascending position values

Specifications	ECN 425 – Singletum	EQN 437 – Multitum
Valid for	ID 678920-01	ID 678922-01
Functional safety for applications up to	<p>As single-encoder system for monitoring functions</p> <ul style="list-style-type: none"> SIL 1 as per EN 61508 (further basis for testing: EN 61800-5-2) Category 2, PL c as per EN ISO 13849-1:2015 <p>As single-encoder system for closed-loop functions</p> <ul style="list-style-type: none"> SIL 2 as per EN 61508 (further basis for testing: EN 61800-5-2) Category 3, PL d as per EN ISO 13849-1:2015 <p>Safe in the singletum range</p>	
PFH	$\leq 10 \cdot 10^{-9}$ (probability of dangerous failure per hour)	
Safe position ¹⁾	<p>Encoder: $\pm 1.76^\circ$ (safety-related measuring step: SM = 0.7°)</p> <p>Mechanical coupling: $\pm 2^\circ$ (fault exclusion for loosening of shaft and stator coupling, designed for accelerations $\leq 300 \text{ m/s}^2$)</p>	
Interface	EnDat 2.2	
Ordering designation	EnDat22	
Position values per revolution	33 554 432 (25 bits)	
Revolutions	-	4096 (12 bits)
Calculation time t_{cal} Clock frequency	$\leq 7 \mu\text{s}$ $\leq 8 \text{ MHz}$	
System accuracy	$\pm 20''$	
Electrical connection	Cable, 1 m, with 8-pin M12 coupling (male)	
Cable length	$\leq 100 \text{ m}$ (see EnDat description in the <i>Interfaces of HEIDENHAIN Encoders</i> brochure)	
Supply voltage	DC 3.6 V to 14 V	
Power consumption ²⁾ (max.)	<p>At 3.6 V: $\leq 600 \text{ mW}$</p> <p>At 14 V: $\leq 700 \text{ mW}$</p>	<p>At 3.6 V: $\leq 700 \text{ mW}$</p> <p>At 14 V: $\leq 800 \text{ mW}$</p>
Current consumption (typical)	At 5 V: 85 mA (without load)	At 5 V: 105 mA (without load)
Shaft	Blind hollow shaft for axial clamping $\varnothing 12.7 \text{ mm}$ (67M)	
Speed	$\leq 12\,000 \text{ rpm}$	
Starting torque at 20 °C (typical)	0.01 Nm	
Moment of inertia of rotor	$3.6 \cdot 10^{-6} \text{ kgm}^2$	
Angular acceleration of rotor	$\leq 5 \cdot 10^4 \text{ rad/s}^2$	
Natural frequency of stator coupling	$\geq 1800 \text{ Hz}$	
Axial motion of measured shaft	$\leq \pm 0.5 \text{ mm}$	
Vibration 55 Hz to 2000 Hz Shock 6 ms	$\leq 300 \text{ m/s}^2$ (EN 60 068-2-6); 10 Hz to 55 Hz constant over distance 4.9 mm peak to peak $\leq 2000 \text{ m/s}^2$ (EN 60 068-2-27)	
Min. operating temp.	Stationary cable: $-30 \text{ }^\circ\text{C}$; Moving cable: $-10 \text{ }^\circ\text{C}$	
Max. operating temp.	100 °C	
Trigger threshold of error message for excessive temperature	125 °C (measuring accuracy of internal temperature sensor: $\pm 4 \text{ K}$)	
Relative humidity	$\leq 93 \%$ (40 °C/21 d as per EN 60 068-2-78); without condensation	
Protection EN 60 529	IP64 (see <i>Insulation</i> under <i>General mechanical information</i> in the <i>Encoders for Servo Drives</i> brochure; contamination from the ingress of liquid must be prevented)	
Mass	$\approx 0.25 \text{ kg}$	

1) Further tolerances may apply in subsequent electronics after position value comparison (contact mfr. of subsequent electronics)

2) See *General electrical information* in the *Interfaces of HEIDENHAIN Encoders* brochure

Mounting

The shaft of the rotary encoder is slid onto the motor's drive shaft and fastened with a central screw. It must particularly be ensured that the positive-locking element of the stator coupling securely engages the corresponding slot in the measured shaft. A screw with material bonding anti-rotation lock must be used (see *Mounting accessories*). The stator coupling is clamped by means of an axially tightenable screw in a location hole.

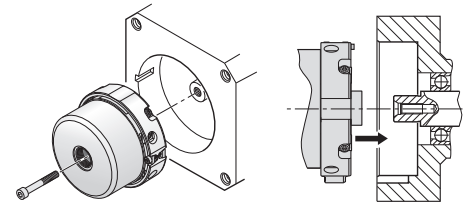

Requirements on the motor side for safe mechanical coupling:

	Mating shaft	Mating stator
Material	Steel	Aluminum
Tensile strength R_m	$\geq 600 \text{ N/mm}^2$	$\geq 220 \text{ N/mm}^2$
Interface pressure P_G	$\geq 500 \text{ N/mm}^2$	$\geq 200 \text{ N/mm}^2$
Surface roughness R_z	$\leq 16 \mu\text{m}$	
Coefficient of thermal expansion α_{therm}	$10 \cdot 10^{-6} \text{ K}^{-1}$ to $17 \cdot 10^{-6} \text{ K}^{-1}$	$\leq 25 \cdot 10^{-6} \text{ K}^{-1}$

For the design of the mechanical fault exclusion for the shaft connection, the following maximum torque M_{max} must be considered:

$$M_{\text{max}} = 1.0 \text{ Nm}$$

The customer's mechanical design must ensure that the maximum torque M_{max} occurring in the application can be transmitted.

Mounting accessories

Screws

Screws (central screw, fastening screws) are not included in delivery and can be ordered separately.

ECN 1325, EQN 1337	Screws ¹⁾		Quantity
Central screw for fastening the shaft	DIN 6912-M5×25-08.8-MKL	ID 202264-55	10 or 100

1) With coating for material-bonding anti-rotation lock

For further mounting information and mounting aids, please refer to the relevant mounting instructions and the *Encoders for Servo Drives* brochure. The mounting can be tested with the PWM 21 and the ATS software.

Integrated temperature evaluation

This rotary encoder features a temperature sensor integrated in the encoder electronics. The digitized temperature value is transmitted purely serially over the EnDat protocol. Note that temperature measurement and transmission are not secure in the sense of functional safety.

With regard to the internal temperature sensor, the encoder supports two-stage cascaded signaling of excessive temperature. This consists of an EnDat warning and an EnDat error message.





In compliance with the EnDat specification, when the temperature reaches the warning threshold for excessive temperature of the internal temperature sensor, it triggers an EnDat warning (EnDat memory area for operating status, word 1 – warning, bit 2¹ – temperature exceeded). This warning threshold for the internal temperature sensor is saved in the EnDat memory area “Operating parameters,” word 6 – “Threshold sensitivity warning bit for exceeded temperature,” and can be individually adjusted. A product-specific default value is saved before shipping. The temperature measured by the internal temperature sensor is higher by a device-specific and application-specific amount than the temperature at the measuring point M1 in accordance with the dimension drawing.

The encoder features a further, but non-adjustable trigger threshold for the EnDat error message for excessive temperature of the internal temperature sensor, which when exceeded triggers an EnDat error message (EnDat memory area for operating status, word 0 – error messages, bit 2² – position and, in the additional datum 2 operating status error sources, bit 2⁶ – temperature exceeded). This threshold sensitivity depends on the device and is shown in the specifications.

HEIDENHAIN recommends setting the warning threshold depending on the application so that it lies sufficiently below the trigger threshold for the EnDat error message for excessive temperature. The encoder’s intended use requires compliance with the operating temperature at the measuring point M1.

Electrical connection

Cables with M12 connecting elements

PUR connecting and adapter cables \varnothing 6 mm; $(4 \times 0.14 \text{ mm}^2) + (4 \times 0.34 \text{ mm}^2)$; $A_P = 2 \times 0.34 \text{ mm}^2$		
Connecting cable with 8-pin M12 connector (female) and 8-pin M12 coupling (male)		ID 368330-xx
Connecting cable with 8-pin M12 connector (female) and free cable end		ID 634265-xx ¹⁾
Adapter cable with 8-pin M12 connector (female) and 15-pin D-sub connector (female)		ID 533627-xx
Adapter cable with 8-pin M12 connector (female) and 15-pin D-sub connector (male)		ID 524599-xx





A_P : Cross section of power supply lines

1) Connecting element must be suitable for the maximum clock frequency used

The electromagnetic compatibility of the complete system must be ensured!

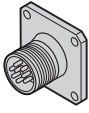
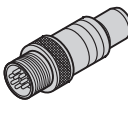
Note for safety-related applications: Provide bit error rate as per specification 533095!

Pin layout

8-pin M12 coupling								
								
	Power supply				Absolute position values			
	8	2	5	1	3	4	7	6
	U_P	Sensor U_P	0 V	Sensor 0 V	DATA	DATA	CLOCK	CLOCK
	Brown/Green	Blue	White/Green	White	Gray	Pink	Violet	Yellow

Cable shield connected to housing; **Up** = Power supply

Sensor: The sense line is connected in the encoder with the corresponding power supply.

Vacant pins and wires must not be used.

Note for safety-related applications: Only completely assembled HEIDENHAIN cables are qualified. Do not modify cables or exchange their connectors without first consulting with HEIDENHAIN Traunreut.

HEIDENHAIN

DR. JOHANNES HEIDENHAIN GmbH

Dr.-Johannes-Heidenhain-Straße 5

83301 Traunreut, Germany

+49 8669 31-0

+49 8669 32-5061

E-mail: info@heidenhain.de

www.heidenhain.de

This Product Information document supersedes all previous editions, which thereby become invalid. The basis for ordering from HEIDENHAIN is always the Product Information document edition valid when the order is made.

 **Further information:** Adhere to the information in the following documents to ensure the correct and intended operation of the encoder:

- *Encoders for Servo Drives* brochure: 208922-xx
- *Interfaces of HEIDENHAIN Encoders* brochure: 1078628-xx
- *ECN 425, EQN 437 Mounting Instructions*: 722594-xx
- *Safety-Related Position Measuring Systems* Technical Information: 596632-xx
- For implementation in a safe control or inverter: *Specification 533095*
- *Cables and Connectors* brochure: 1206103-xx